

BKT
mobiliario
urbano

Ficha Técnica
Product Sheet

BAN-005

Banca Bench



Este producto es altamente configurable, con opciones en materiales, tamaños, colores y accesorios, y dos tipos de instalación por variante.

This product is highly configurable, with options in materials, sizes, colors, and accessories, and two types of installation per variant.

Respaldo Acero al Carbón

Carbon Steel Backrest

Tipología

Typology

Dimensiones

Size



Normal

63 / 120 / 78 cm

25 / 47 / 31 in

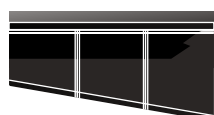

Mediano

97 / 120 / 78 cm

Medium

38 / 47 / 31 in

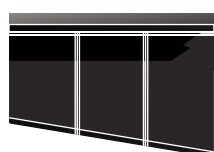

Grande

129 / 120 / 78 cm

Large

51 / 47 / 31 in

Respaldo Acero Inoxidable

Carbon Steel Backrest



Normal

63 / 120 / 78 cm

25 / 47 / 31 in

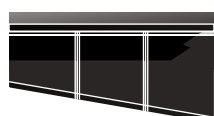

Mediano

97 / 120 / 78 cm

Medium

38 / 47 / 31 in

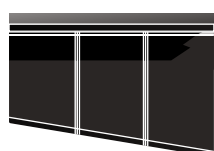

Grande

129 / 120 / 78 cm

Large

51 / 47 / 31 in

Respaldo Madera
Carbon Steel Backrest

Tipología
Typology

Dimensiones
Size



Normal

63 / 120 / 78 cm

25 / 47 / 31 in



Mediano
Medium

97 / 120 / 78 cm

38 / 47 / 31 in

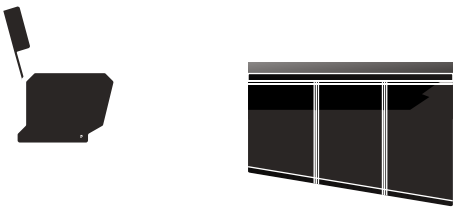

Grande
Large

129 / 120 / 78 cm

51 / 47 / 31 in

BAN-005



Banca Bench

Diseñado para espacios públicos y hecho de concreto polimérico de alta calidad para garantizar durabilidad y seguridad. Se presenta en múltiples tamaños y colores, brindando una estructura resistente y consistente para ofrecer longevidad en el entorno donde se inserte.

Designed for public spaces and made of high-quality polymer concrete to ensure durability and security. Presented in multiple sizes and colors, features a sturdy structure and impressive resistance for added safety and security, to offer longevity in any context where it is placed.

Peso (M): 211 kg

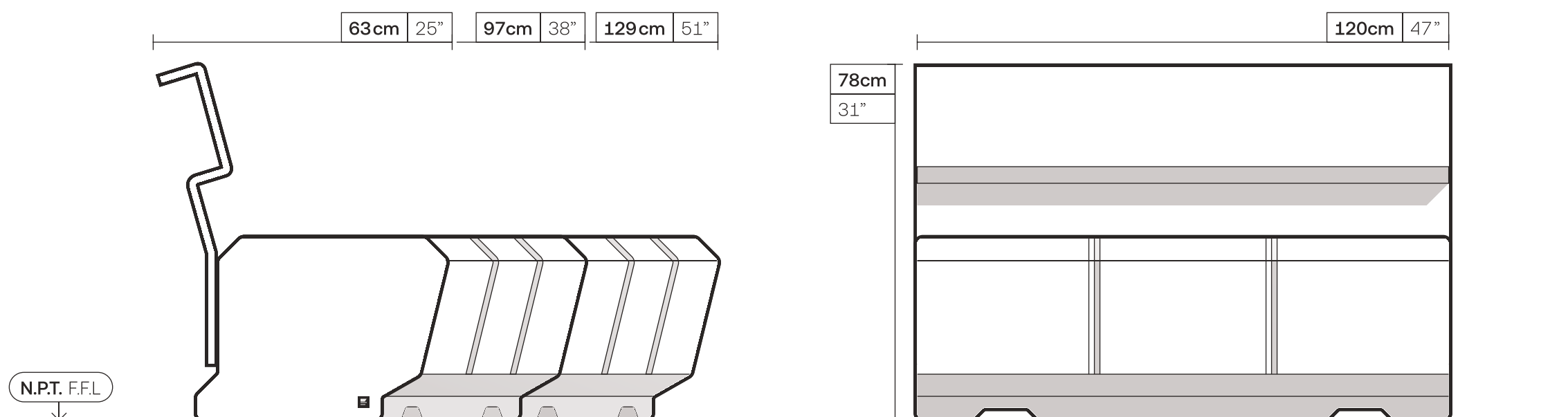

Apariencia Appearance

Asiento Seat

- **Concreto Polimérico** Polymer Concrete

Respaldo Backrest

- **Acero al Carbón** Carbon Steel
- **Acero Inoxidable** Stainless Steel

Otros Others

- **Madera Tropical** Tropical Wood

Configuraciones Settings

Tamaños Sizes

- **Chico** Small
- **Mediano** Medium
- **Grande** Large

Instalación Installation

- **Sobrepuesto** Laid

Para más información sobre las garantías, encuentralas en nuestro sitio web.

For more information about the warranties, find them on our website.

Garantías

Guarantees



Zona Urbana

Urban Area

Se refiere a zonas de baja polución, secas y frías, de baja humedad o algunas zonas desérticas.

It refers to areas of low pollution, dry and cold, low humidity or some desert areas.



Brisa Marina

Sea Breeze

Se refiere a embarcaderos o malecones con brisa de un grado muy alto de salinidad y neblina marina.

It refers to piers or promenades with very high levels of salt fog.



Alta Humedad

High Humidity

Se refiere a zonas húmedas sin niebla salina o con grado medio de salinidad con cercanía a la costa.

It refers to humid areas without salt fog or with a medium degree of salinity close to the coast.

Concreto Polimérico

Polymer Concrete



- 120 meses months
- 120 meses months
- 60 meses months

Acero al Carbón

Carbon Steel



- 60 meses months
- 12 meses months

Maderas

Woods



- 60 meses months
- 60 meses months
- 36 meses months

Acero Inoxidable

Stainless Steel



- 60 meses months
- 24 meses months
- 12 meses months



 [bkt_mobiliario.urbano](https://www.instagram.com/bkt_mobiliario.urbano)

[bktmobiliario.com](https://www.bktmobiliario.com)

 Herrera y Cairo 980
Col. Jesús 44200
Guadalajara, Jal. MX

 MiBici GDL-10
 L1, Estación Refugio

 +52 33 3825 7333
+52 33 3165 8582

 info@bktmobiliario.com